

PUSHBUTTONS AND TOGGLES - MINIATURE

8350 / 8351 / 8352 / 8353

- › Double-break flexible leaf snap-action mechanism
- › Momentary or maintained action
- › Changeover-SPDT microswitch as standard
- › One, two and three-pole configurations
- › Long life
- › Ratings from 10 mA 4 V_{DC} to 10 A 250 V_{AC}
- › Operating temperature -40 °C up to +125 °C
- › Choice of connections

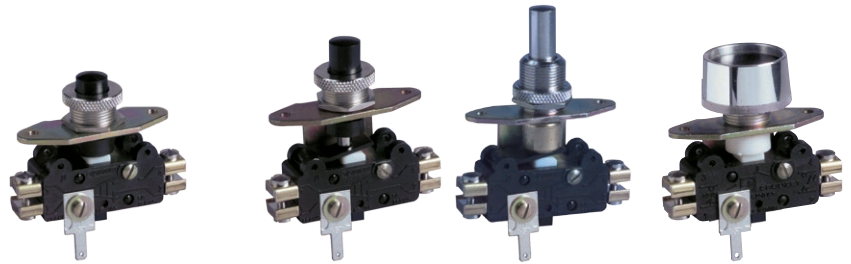

Main specifications

		Pushbuttons				
		Momentary	Momentary + Maintained*	Momentary	Momentary	Momentary
		Standard	Long travel	Long travel	Long travel Metal plunger	Recessed button
		83507	83553 ***	83513	83522	83535
Function	Connections					
1-pole (835--0)	I (changeover)	W1 (screw)	●	83513003	83522011	83535012
	I (changeover)	W2 (solder)	83553003	83513005	83522005	83535007
	I (changeover)	W3 (QC 6.3x0.8)	●	83513010	83522016	83535021
2-pole (835--3)	I (changeover)	W1 (screw)	●	83513309	●	●
	I (changeover)	W2 (solder)	●	83513301	83522302	83535306
	I (changeover)	W3 (QC 6.3x0.8)	●	●	●	●
Electrical characteristics						
Rating nominal / 250 V AC (A)		10	10	10	10	10
Rating thermal / 250 V AC (A)		17.5	17.5	17.5	17.5	17.5
Mechanical characteristics						
Maximum operating force, 1-pole (N)		4	4/25	4	4	4
Maximum operating force, 2-pole (N)		8	8/25	8	8	8
Maximum total travel force, 1-pole (N)		-	-	35	15	-
Maximum total travel force, 2-pole (N)		-	-	35	15	-
Pretravel (mm)		1.1	1.1	1.1	1.1	1.1
Total travel (mm)		2.2	6	6	6	2.2
Ambient operating temperature (°C)		-40 → +85	-40 → +85	-40 → +85	-40 → +85	-40 → +85
Mechanical life (operations)		10 ⁶	5 x 10 ⁵	10 ⁶	10 ⁶	10 ⁶
Weight, 1-pole (g)		26	24	30	40	29
Weight, 2-pole (g)		39	34	43	53	42

* Push slightly for momentary action. Fully push for maintained action, to latch, then to unlatch

** One side momentary, the other side maintained

*** Please consult us

Additional specifications

- Buttons, toggles: POM, PA66 (83502, 83507), nickel-plated brass (83522)
- Mounting brackets: zinc-plated steel
- Barrels, knurled bezels, nuts: nickel-plated brass
- Button collars: chrome-plated ABS (83533, 83535)
- Contacts: silver alloy (gold-plated silver alloy: on request)
- Terminals: brass, copper nickel (W2)
- Sealing cap (accessory): silicone rubber

- Degree of protection: IP40 (button side), IP50 with cap (accessory)
- Protection against electric shock: Class I (see also "installation recommendations")
- Rated insulation voltage U_i: 250 V (for U_i 400 V, please consult us)
- Impulse withstand voltage U_{imp}: 2.5 kV
- Pollution degree: 3
- Certification marks: cURus on request / (CC)

Product adaptations



- › Functions on request: normally closed (R) or normally open (C) SPST microswitches
- › 3-pole configurations: 835--6 (except for 83515, 83516, 83517)
- › High DC switching capacity: 5 A 250 V_{DC} (with 83154 microswitches)
- › Dual-current variants with gold-plated contacts for use from 10mA to 5A
- › Built-in screw connections (with 83112 microswitches)
- › Solder connections on front face (with 83109 microswitches)
- › Sealing cap accessory for IP50 protection on button side (for 83502, 83507, 83513, 83553)
- › Red button on 83507 and 83535 models
- › High operating temperature: +125 °C (on 83507, 83513, 83522)
- › cURus approved models

Standard product

Product made to order

● Contact us



Main specifications (continued)					
Tandem buttons		Toggles			Action
Maintained		Momentary	Maintained	Momentary + Maintained **	
Standard	Recessed buttons	3 positions Auto-return to center	3 positions	3 positions Auto-return to center on momentary side	
83502	83533	83515	83516	83517	
83502005	83533002	83515006	83516002	●	Func. Conn.
83502002	83533003	83515010	●	●	1-pole W1
83502008	83533005	●	●	●	(835-0) W2
83502306	●	83515302	83516303	●	W3
83502302	●	83515301	83516301	●	2-pole W1
●	●	●	●	●	(835-3) W2
					W3
10	10	10	10	10	Electrical
17.5	17.5	17.5	17.5	17.5	Nom rating (A)
					Therm rating (A)
20	20	8	8	8	Mechanical
20	20	10	10	10	OF max, 1p (N)
-	-	-	-	-	OF max, 2p (N)
-	-	-	-	-	TTF max, 1p (N)
-	-	-	-	-	TTF max, 2p (N)
-	-	± 16°	-	± 16°	PT (mm)
4	4	± 24°	± 24°	± 24°	TT (mm)
-40 → +85	-40 → +85	-40 → +85	-40 → +85	-40 → +85	Temp (°C)
5 x 10 ⁵	5 x 10 ⁵	10 ⁵	10 ⁵	10 ⁵	Mech. life (op)
53	54	50	50	50	Weight, 1p (g)
64	70	71	71	71	Weight, 2p (g)

Principles (per pole)

Double break snap-action switch

Changeover - SPDT (form Za):



Normally closed - SPST-NC (form Y):

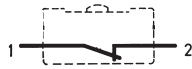

Normally open - SPST-NO (form X):

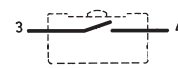

Both circuits must be used at same polarity

Changeover - 2 x SPDT (2 x form Za): for 83515/83516/83517



As standard: each SPDT microswitch is operated by one lever maximum position

As adaptation: both SPDT microswitches can be simultaneously operated by one lever maximum position ; the other maximum position being locked. (SP3218)

Curves

Operating curve for types 8350 / 8351 / 8352 / 8353

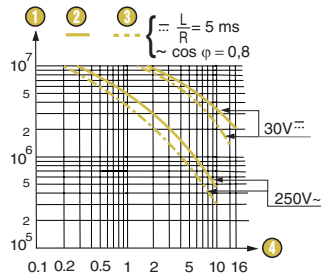

- 1 Number of cycles
- 2 Resistive circuit
- 3 Inductive circuit
- 4 Current in Amps

The operating curve relates to contact life, but switch durability is also limited by mechanical life of operating device: see “Mechanical life”

Dimensions

Products

83502

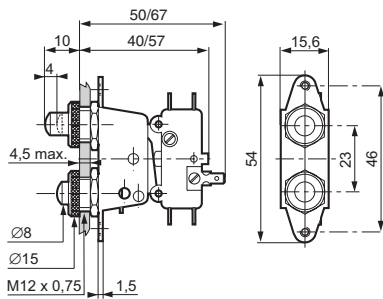

83507

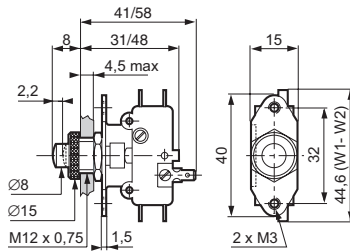

83513

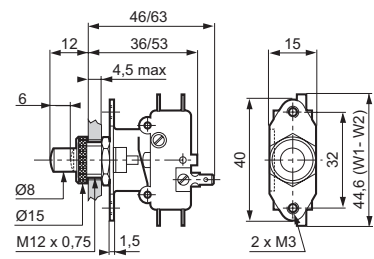

83515 - 83516 - 83517

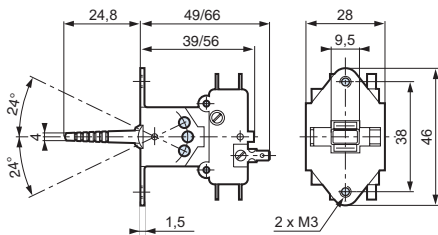

83522

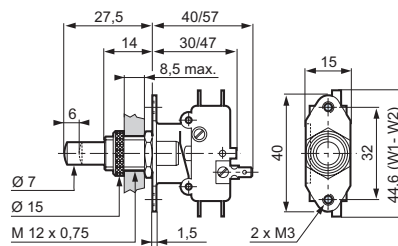

83535

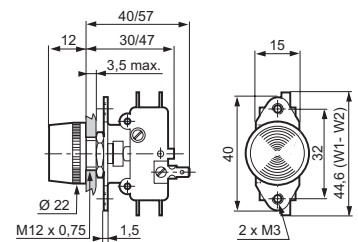

83533

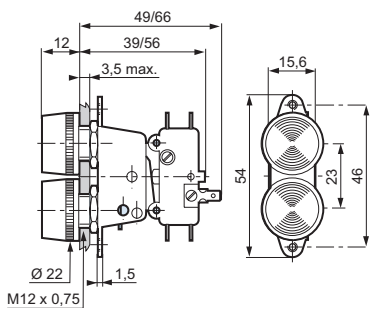

Panel cutouts

83502 - 83533

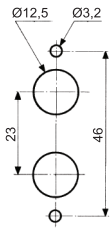

83507 - 83513 - 83522 - 83535

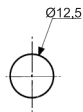

83515 - 83516 - 83517

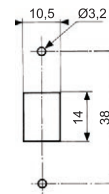

Connections

W1 screw with clamp

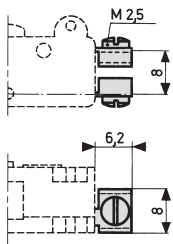

W2 solder

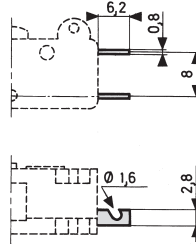

W3 quick-connect 6.3 x 0.8

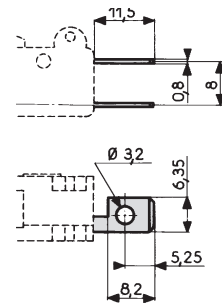

Mounting accessories

Knurled nut

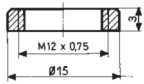

Hexagonal nut

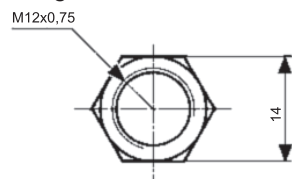

Thickness: 1.5

Knurled bezel

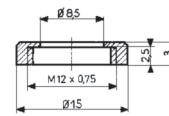

Sealing cap

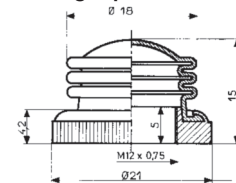

Mounting accessories

Part numbers for accessories

70162306

70602118

70602117

70135750

70135751

Knurled nut

Hexagonal nut-M12

Knurled bezel-M12

Sealing cap-black

Sealing cap-red

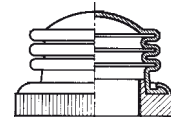
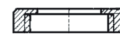
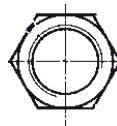

Installation recommendations

See "Basic technical concepts"

For 83522: to ensure protection against electric shock, direct manual operation on the metal plunger is not permitted above 48 V.

How to order

Use the 8 digit part numbers when they are defined

Other cases, precise:

Type of switch/nb of poles - Function - Connection - UL approval* - Adaptation* + Mounting accessories*

* if needed

Example: 835073 | W3 UL + 70135750

Warning:

The product information contained in this catalogue is given purely as information and does not constitute a representation, warranty or any form of contractual commitment. Crouzet Automatismes SAS and its subsidiaries reserve the right to modify their products without notice. It is imperative that we should be consulted over any particular use or application of our products and it is the responsibility of the buyer to establish, particularly through all the appropriate tests, that the product is suitable for the use or application. Under no circumstances will our warranty apply, nor shall we be held responsible for any application (such as any modification, addition, deletion, use in conjunction with other electrical or electronic components, circuits or assemblies, or any other unsuitable material or substance) which has not been expressly agreed by us prior to the sale of our products.